

Spot		Medium		Flood	
16°		28°		40°	
m	ø	m	ø	m	ø
1.0	0.28	1.0	0.50	1.0	0.73
2.0	0.56	2.0	1.00	2.0	1.46
3.0	0.83	3.0	1.51	3.0	2.18

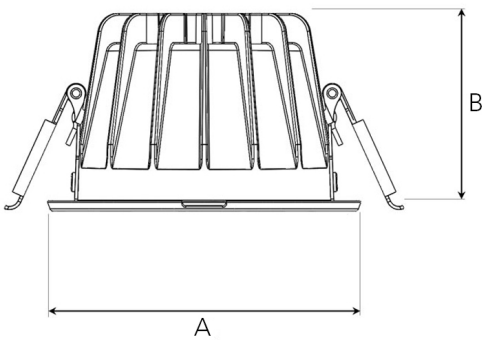

A 102 B 65 (mm)



Saw instruction: ø 92

Titan mini 2000

Technical specification

Recessed down light with chip on board and separated NL Power LED electronic ballast for optimal life time and light flow performance. High quality reflectors with three different beam spreads. Lamp housing of die-cast aluminium for optimal cooling and low weight.

Model and colors Available in white, black and grey.

Area of use Down light for indoor applications.

Technical data

Mains (input) voltage	220-240 V
Total weight	0,28 kg
Form of protection	IP 20, class III
Light source	LED
Operating position	Vertical
Start time	Instant
Driver	Stand alone, included
Optics	Metalized aluminum reflector
Beam spreads	Spot, Medium, Flood

Art no	Description	Color
308-510-10	Spot	White
308-510-20	Spot	Black
308-510-30	Spot	Grey
308-511-10	Medium	White
308-511-20	Medium	Black
308-511-30	Medium	Grey
308-512-10	Flood	White
308-512-20	Flood	Black
308-512-30	Flood	Grey
236-318-103	Diffuser glass	-
236-316-103	Assymetric glass	-

Type	Delivered lumen output (lm)	System power (W)	EEI ³
930	1890	17	A++
940	1890	17	A++
840	1890	14	A++

Note

The above article numbers applies to 930.

Product available in other Kelvin temperatures on request. Product available with DALI option on request. Final shipping destination may require minor modifications of components as well as article numbers, be sure to state the country in which the fixtures will be used.