

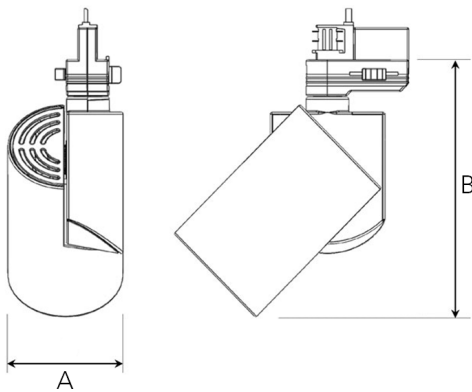

Spot		Medium		Flood	
16°		28°		40°	
m	ø	m	ø	m	ø
1.0	0.28	1.0	0.50	1.0	0.73
2.0	0.56	2.0	1.00	2.0	1.46
3.0	0.83	3.0	1.51	3.0	2.18



A 87 B 190 (mm)

Zylinder mini 2000

Technical specification

Track light with incorporated electronic gear and Chip on board. High quality reflectors with three different beam spreads. Lamp housing of die-cast aluminium for optimal cooling, long lifetime and low weight. Black front ring.

Model and colors Available in white, black and grey.

Area of use Track light for indoor applications.

Technical data

Mains (input) voltage	220-240 V
Total weight	0,67 kg
Form of protection	IP 20, class I
Light source	LED
Operating position	360°/90°
Start time	Instant
Driver	Built in
Optics	Metalized aluminum reflector
Beam spreads	Spot, Medium, Flood

Art no	Description	Color
298-510-10	Spot	White
298-510-20	Spot	Black
298-510-30	Spot	Grey
298-511-10	Medium	White
298-511-20	Medium	Black
298-511-30	Medium	Grey
298-512-10	Flood	White
298-512-20	Flood	Black
298-512-30	Flood	Grey
298-317-001	Anti dazzle snoot	Black
298-210-100	Flaps kit	-
298-315-001	Honeycomb filter	-
298-314-001	Filter holder	-
236-318-103	Diffuser glass	-
236-316-103	Assymetric glass	-

Type	Delivered lumen output (lm)	System power (W)	EEI ³
930	1890	17	A++
940	1890	17	A++
840	1890	14	A++

Note

The above article numbers applies to 930.

Product available in other Kelvin temperatures by request. Final shipping destination may require minor modifications of components as well as article numbers, be sure to state the country in which the fixtures will be used.